

Firebreak 44 Fire Resistant Expanding Foam

TECHNICAL DATA SHEET

Firebreak 44 is a ready-to-use fire resistant expanding adhesive foam designed for internal use where fire resistant and/or acoustic joints are required or to seal around small cable and metallic pipe service penetrations through walls.

Description

Firebreak 44 is a one-component fire resistant expanding adhesive foam designed for internal use where fire resistant and/or acoustic joints are required. It is also suitable to seal around small cable and metallic pipe service penetrations through walls. Supplied in aerosol containers it is ready to use, fast and convenient.

Performance

Firebreak 44 has been tested to the latest European requirements for applications in walls.

- Fire Classification to EN 13501-2 (ETA 21/0212 & 21/0211)
- Independently tested to EN 1366-3: 2009 and EN 1366-4: 2006 providing up to 4 hours fire resistance
- Gap seals in rigid walls (masonry, concrete) of 92mm minimum thickness
- Both horizontal and vertical gaps tested
- Tested in conjunction with metal pipes and a variety of single and bunched cables
- Fire designs combining Firebreak 44 with stone mineral wool backing or Firebreak 22

sealant facing to achieve extended fire performance

- Class B1 reaction to fire classification when tested to the requirements of DIN 4102
- Acoustic testing to EN ISO 140: Part 3: 2005 sealing gaps up to 20mm wide in a 100mm thick wall and achieving $RST,w (C;Ctr) = 60 (-1;-5)$ dB acoustic performance
- Gas and smoke containing (typically 80+% closed cell)
- Excellent adhesion to most common building substrates, including porous materials, without the use of primers
- Mechanical and durability testing to EAD 350454-00-1104 & EAD 350141-00-1106; Y_2 (internal use with exposure to temperatures below 0°C)
- Mould resistant
- CFC free
- VOC emissions classification: M1 (highest European classification)



Other Properties

- Colour: red
- Applied density: typically 42kg/m³
- Tack free time: typically 10 to 20 minutes (longer for colder conditions)
- Full cure time: typically 2 to 4 hours dependant on temperature, RH and depth of seal
- Application temperature range: +5°C to +30°C

Linear gaps in masonry/concrete walls of minimum thickness 150mm

Maximum gap size (mm)	Seal position	Backing material	Backing size (mm)	Seal depth (mm)	Fire performance (mins)
Integrity & insulation (EI)					
10	Full depth	N/A	N/A	150	90
20	Full depth	N/A	N/A	150	60
50	Both faces	Mineral wool*	50	50	180
50	Central	N/A	N/A	130**	240

*Nominal 90kg/m³. **10mm deep Firebreak 22 Fire Resistant Acrylic Sealant to both faces.

Linear gaps against timber in masonry/concrete walls of minimum thickness 150mm

Maximum gap size (mm)	Seal position	Backing material	Backing size (mm)	Seal depth (mm)	Fire performance (mins)
Integrity & insulation (EI)					
20	Full depth	N/A	N/A	150	90*

*EI 60 for horizontal gaps.

Linear gaps against timber masonry/concrete walls of minimum thickness 92mm

Maximum gap size (mm)	Seal position	Backing material	Backing size (mm)	Seal depth (mm)	Fire performance (mins)
Integrity & insulation (EI)					
20	Full depth	N/A	N/A	92*	60
20	Central	N/A	N/A	72**	120

*19mm thick softwood architrave covering both faces of seal. **10mm deep Firebreak 22 Fire Resistant Acrylic Sealant to both faces.

Cable penetration seals in masonry/concrete walls of minimum thickness 150mm

Opening diameter (mm)	Penetrating service	Specimen description			Fire performance (mins)	
		Exposed face	Middle	Unexposed face	Integrity (E)	Integrity & insulation (EI)
100	Bundle of up to 5# 20mm dia. cables + 26# 15mm dia. cables	Single layer of 75mm wide Firebreak FX200 Sealstrip intumescent sheet positioned centrally around inside perimeter of opening + 150mm deep Firebreak 44 PU Foam			120	90
100	Bundle of up to 4# 20mm dia. cables + 15# 15mm dia. cables	50mm deep Firebreak 44	50mm deep mineral wool*	50mm deep Firebreak 44	120	120
50	Bundle of up to 1# 20mm dia. cables + 7# 15mm dia. cables	50mm deep Firebreak 44			120	120
50	Bundle of up to 1# 20mm dia. cables + 3# 15mm dia. cables	50mm deep Firebreak 44	50mm deep mineral wool*	50mm deep Firebreak 44	120	120
40	Single 30mm dia. cable	150mm deep Firebreak 44 PU Foam			120	90

*Nominal 90kg/m³.

Metal pipe penetration seals in masonry/concrete walls of minimum thickness 150mm

Opening diameter (mm)	Penetrating service	Seal depth (mm)	Insulation	Insulation thickness (mm)	Item	Fire performance (mins)	
						Integrity (E)	Integrity & insulation (EI)
100	89mm dia. steel pipe x minimum 5mm wall thickness	150	nitrile rubber	25	Pipe	90	30
					Insulation*		90
50	35mm dia. copper/steel pipe with minimum 1.2mm wall thickness	150	nitrile rubber	19	Pipe	90	15
					Insulation*		90

*Minimum 500mm insulation interrupted at seal and positioned on non-fire side only or both sides if direction of fire risk is known.

Continues on the next page.

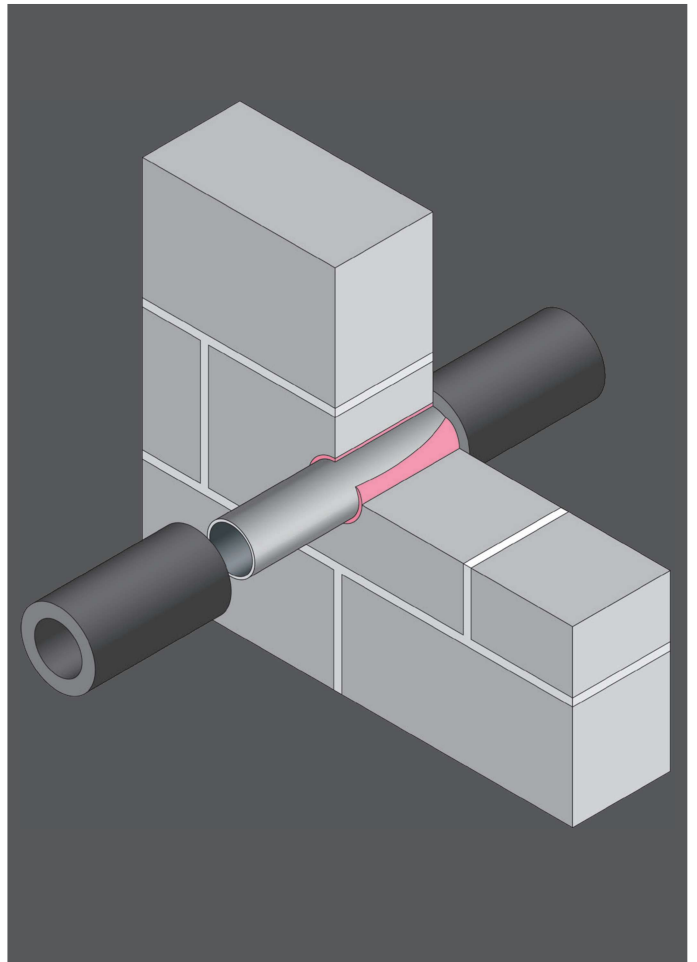
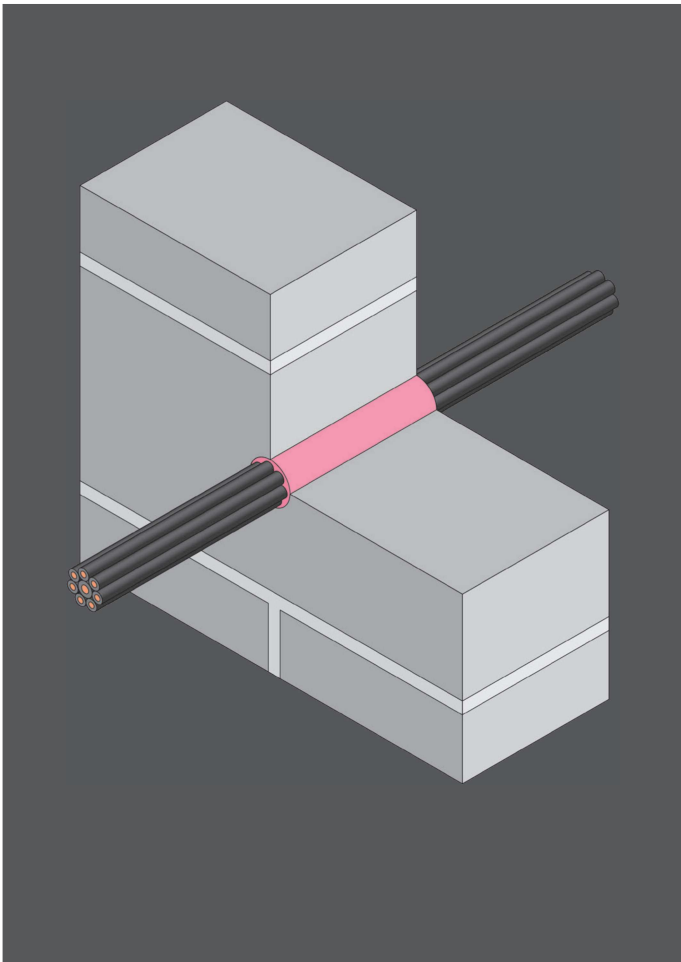
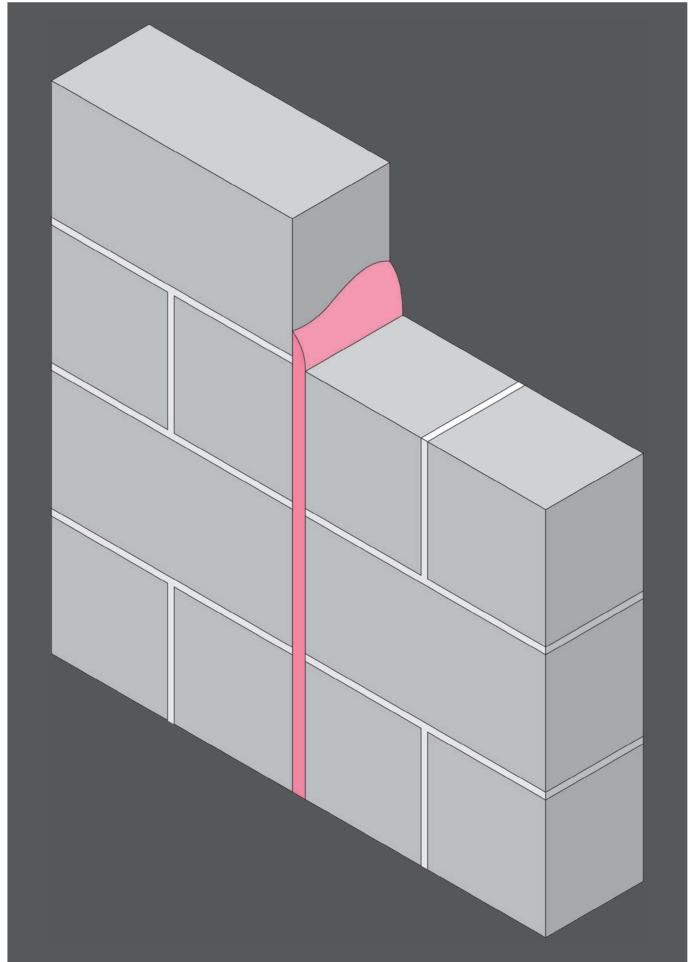
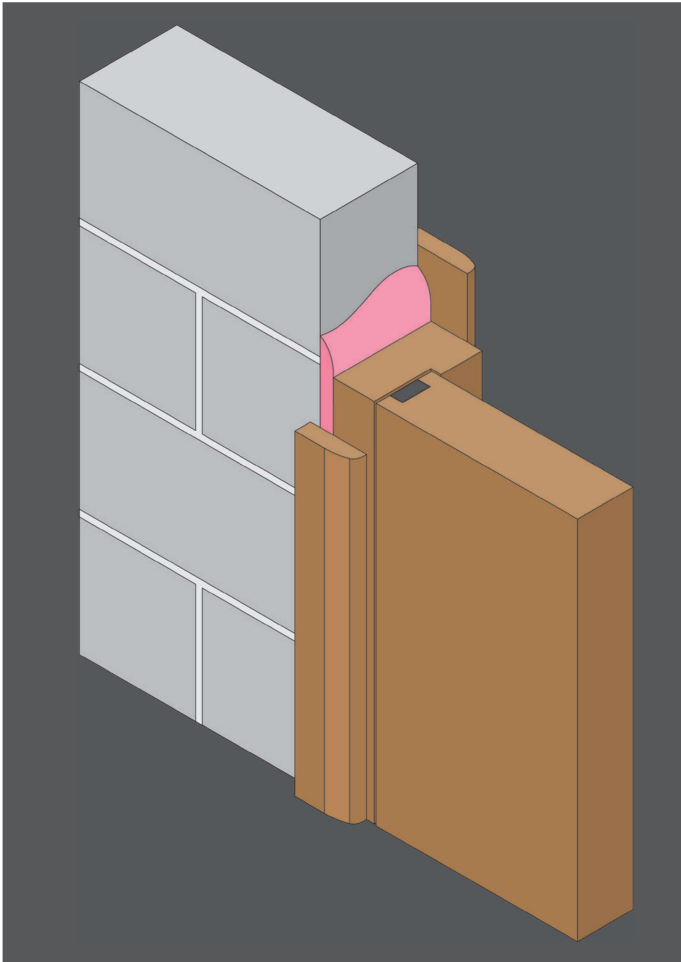

Continues on the next page.

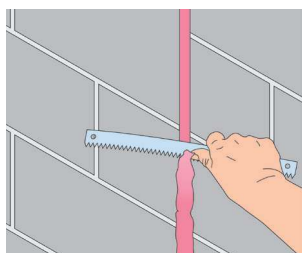
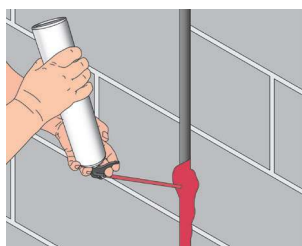
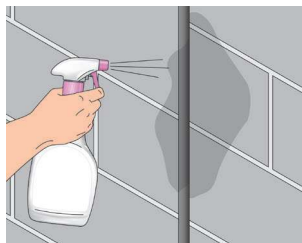
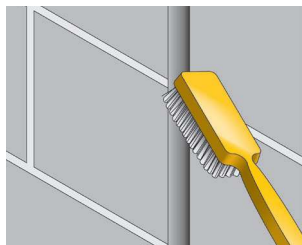

Installation

- Review current Firebreak 44 safety data sheet
- Ensure contact surfaces are clean and dust free
- Apply suitable protection to surrounding surfaces as required

- Lightly moisten contact surfaces to aid adhesion and cure
- Remove cap and carefully fit the plastic valve grip and delivery tube

- Shake can vigorously for about 30 seconds
- Invert the can and using the trigger on the adaptor, tilt the valve to extrude the foam

- Commence foaming at the lowest or deepest point
- Only fill the cavity approximately half full to allow for expansion

- Foam extrusion can be controlled accurately by varying the pressure or tilting the adaptor
- When filling large voids, fill in layers allowing one layer to part cure before foaming the next layer

- As the foam requires moisture to cure care should be taken to ensure surfaces remain moist during application, particularly in hot dry conditions
- The full contents of the can are best used in a single application
- Where this is not possible and following a short period of interruption, any part cured material causing a blockage at the end of the delivery tube can be removed by cutting away the blocked part of the tube
- For longer periods of interruption the tube should be dismantled and both it and the valve cleaned using cellulose thinners

- Please note that in some cases, even after cleaning, foam trapped within the valve may cure due to the presence of air and moisture thereby preventing further dispensing of the remaining contents of the can

- Once cured, any excess foam can be trimmed away using a sharp knife or saw blade to create a neat finish
- The foam is not resistant to UV rays and should be covered with Firebreak 22 Fire Resistant Sealant, plaster, timber architrave or paint if prolonged exposure to sunlight is anticipated
- Clean tools after use using a suitable proprietary cleaner

End use conditions

Firebreak 44 is intended for internal use and has been subjected to EN mechanical and durability testing to support use across a wide temperature range of -5°C to +70°C and high humidity

Maintenance

No routine maintenance is required although periodic inspection for possible damage is recommended. All penetrations seals which are subsequently modified should be made good using Firebreak 44 and where appropriate other materials used to form the original seal

Supply, packaging and usage

Firebreak 44 is supplied in 750ml aerosol cans giving a free expansion yield of up to 38ltr.

Storage

- It is recommended to store in cool dry conditions between 5°C and 20°C
- Store container upright
- Do not expose to temperatures in excess of 50°C

Shelf life

Minimum 24 months from date of manufacture for unopened containers when stored under recommended storage conditions.

Health and safety

Please refer to safety data sheet before use.

Since the product is applied under circumstances beyond our control, Neutron Fire Technologies Limited can accept no direct or consequential liability whether in contract or in tort, for the interpretations of such recommendations and reserves the right to modify the recommendations as necessary.

